

Stock Wardrobe Accessories

Assembly Instruction

Before you start

1. Check the packing and make sure you have all the parts & fittings listed. If not, call our after-sales service team for assistance, we will soon deliver you the missing parts.
2. When you are ready to start, make sure that the right tools to hand, plenty of space and a clean dry area for assembly.

Tools Required

1. Medium Posidrive Screwdriver
2. Spirit Level

Parts List

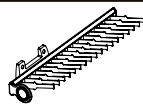
Illustration	Qty
	1

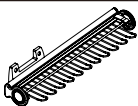
Illustration	Qty
	1

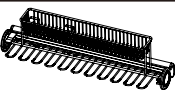
Illustration	Qty
	1

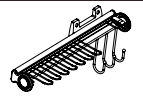
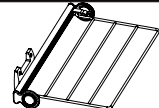

Illustration	Qty
	1

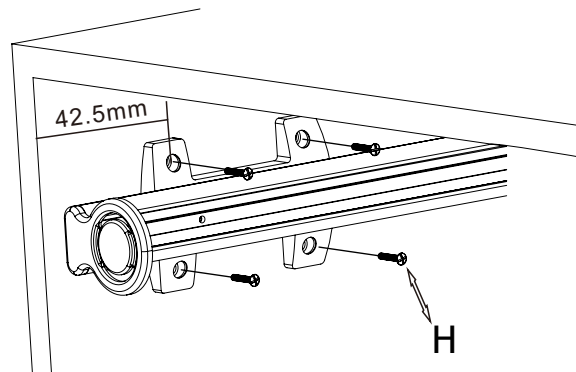
Illustration	Qty
	1

Fittings List

Description	Illustration	Qty
M4*16 Screw	 H x 4	4

Assembly Steps

Fixed the aluminium frame onto the cabinet by Screw M4*16 [H] as shown.



Care & Use

1. Maximum load weight 5kg.
2. Wipe clean with a soft damp cloth, Never use scourers, abrasives or chemical cleaners.
3. Keep the slides get rid of water to protect the slides thus make sure the smooth sliding.
4. For help and assistance, please contact our after-sales services team.